

Town Core Residential Guidelines

Town Core Residential

The many small residential streets bounded by Arrow Highway on the south, Gladstone Street on the north, Walnut Avenue on the east, and the 210 freeway on the west form the majority of the historic building stock of San Dimas. This underlying structure (morphology) of the town core was laid down in 1887 with the coming of the Santa Fe Railway. Development in these areas began late in the 19th century and continued until the Second World War.

Most blocks within the Town Core are 600 feet long in the east-west direction and 300 feet long in the north-south direction. These blocks are bisected in the east-west direction by a service lane or alley. Lot sizes are typically 50 feet wide and 140 feet deep. Nearly all lots front an east-west street and are accessible from the rear via the alleys. To facilitate surface drainage, the east-west streets are severely cambered. Landscaped parkways line the sidewalks of most streets. The traditional development of the 50-foot-wide lot is to build to the 20-foot front-yard setback and to the five feet side-yard setbacks. Vehicular access is taken from the back alley; with such narrow lots, vehicular access from the street is undesirable because the resultant streetscape is of garage doors and paving with very little

landscaping. The severe road camber makes curb cuts for vehicular access technically difficult. Where curb cuts and garages have been allowed in recent years, the results are visually unsatisfactory.

Currently, the alleys throughout the Town Core are not well maintained or visually pleasing. Various planning requirements help to control development along the street fronts and the results are homogeneous and successful. The requirements along the lanes are not as clear, and the results are

less desirable. An organized strategy of public and private improvements for the alleys will result in a greater willingness on the part of residents to use them for access to parking.

Parkways along most streets present difficult maintenance problems both for residents and the city. These parkways and their landscapes are significant contributors to the streetscape and should be maintained. The city could initiate an incentive program to encourage residents to maintain the parkways in front of their houses.

52

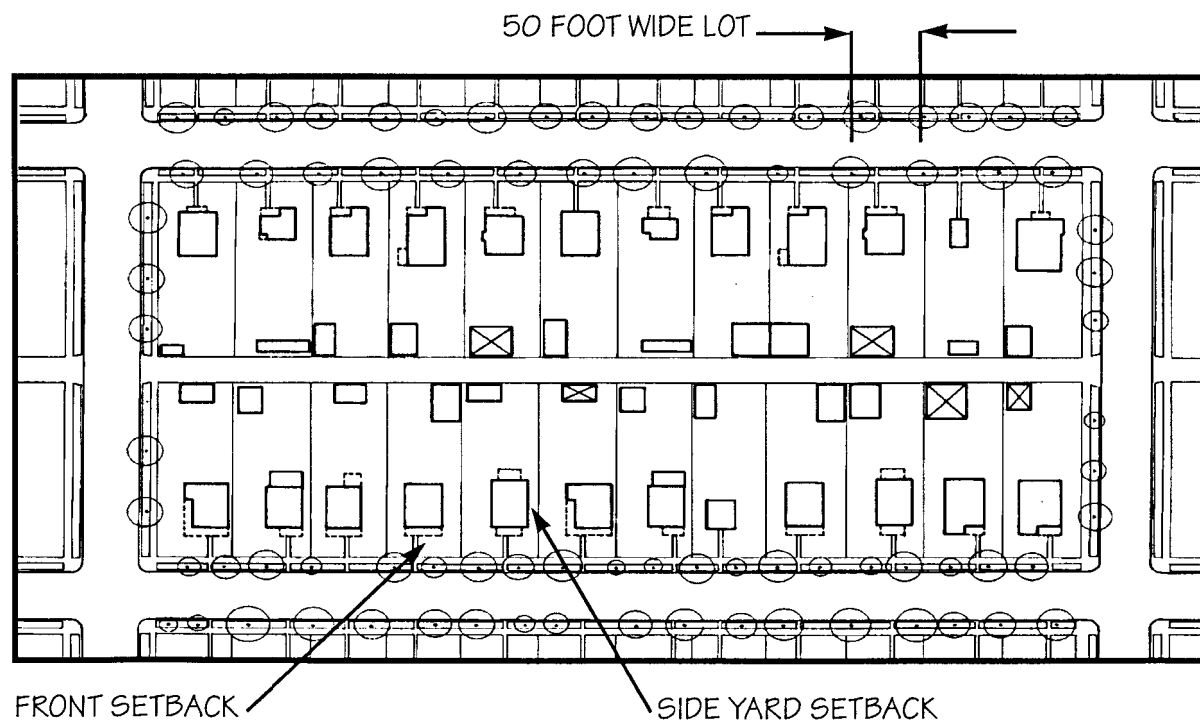

TYPICAL BLOCK IN TOWN CORE RESIDENTIAL AREA

Town Core Residential

The many small residential streets bounded by Arrow Highway on the south, Gladstone Street on the north, Walnut Avenue on the east, and the 210 freeway on the west form the majority of the historic building stock of San Dimas. This underlying structure (morphology) of the town core was laid down in 1887 with the coming of the Santa Fe Railway. Development in these areas began late in the 19th century and continued until the Second World War.

Most blocks within the Town Core are 600 feet long in the east-west direction and 300 feet long in the north-south direction. These blocks are bisected in the east-west direction by a service lane or alley. Lot sizes are typically 50 feet wide and 140 feet deep. Nearly all lots front an east-west street and are accessible from the rear via the alleys. To facilitate surface drainage, the east-west streets are severely cambered. Landscaped parkways line the sidewalks of most streets. The traditional development of the 50-foot-wide lot is to build to the 20-foot front-yard setback and to the five feet side-yard setbacks. Vehicular access is taken from the back alley; with such narrow lots, vehicular access from the street is undesirable because the resultant streetscape is of garage doors and paving with very little

landscaping. The severe road camber makes curb cuts for vehicular access technically difficult. Where curb cuts and garages have been allowed in recent years, the results are visually unsatisfactory.

Currently, the alleys throughout the Town Core are not well maintained or visually pleasing. Various planning requirements help to control development along the street fronts and the results are homogeneous and successful. The requirements along the lanes are not as clear, and the results are

less desirable. An organized strategy of public and private improvements for the alleys will result in a greater willingness on the part of residents to use them for access to parking.

Parkways along most streets present difficult maintenance problems both for residents and the city. These parkways and their landscapes are significant contributors to the streetscape and should be maintained. The city could initiate an incentive program to encourage residents to maintain the parkways in front of their houses.

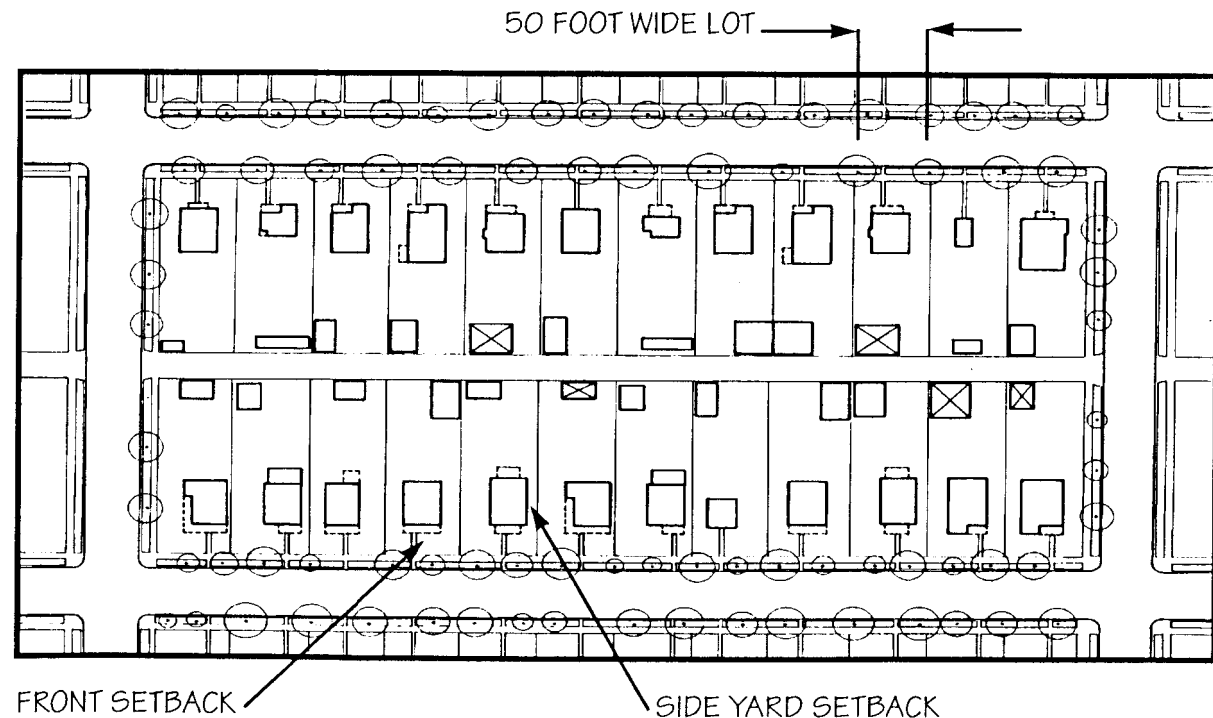

TYPICAL BLOCK IN TOWN CORE RESIDENTIAL AREA

Town Core Residential

KEY ISSUES

- Maintenance and enhancement of qualities inherent in the original planning of this district.
- Protection of existing historic buildings.
- Enhancement of the streetscape with public improvement projects.
- Protection of existing mature landscape.
- Consider providing park or recreational facilities within the district east of San Dimas Avenue and north of Bonita Avenue.

GENERAL RECOMMENDATIONS

- Large mature trees should be protected.
- North-south streets should meet similar planning standards as east-west streets (e.g. setback landscaping, sidewalks, etc.).
- A consistent setback policy should be established for the alleys.
- Develop an incentive program for alley cleanup by residents.
- Parkways should be retained between sidewalks and streets.

RECOMMENDED PUBLIC IMPROVEMENTS

- Parkway that have been replaced with concrete should be returned to landscape.
- A street lighting program should be introduced.
- Overhead power and telephone lines along streets should be placed underground or along the alleys.
- Pave alleys and add street lights with low level lighting (max. 12 feet high), so that they are an attractive alternative to on-street parking.

RECOMMENDED PRIVATE IMPROVEMENTS

- Limit building height to 30 feet for residential buildings.
- Existing setback requirements should be maintained. Front setbacks should not be less than those for adjoining properties.
- Landscaped front yards should be maintained and never paved for parking or vehicular access.
- Fences should be made of wood.

- Additions to historic buildings should harmonize with the architecture of the building. (Note: For specific guidelines for additions to existing buildings, see page 77)
- New building slabs should be 2 feet above the existing grade of front yard to relate to the historic building morphology.
- Roof pitches for all structures should not be less than 3 in 12.
- Parking should be entered only off back alleys, and parking should be provided in garages.
- Walls, fences or doors along lanes should be included in plan, for new construction or rehabilitation.

DISCOURAGED PRIVATE IMPROVEMENTS

- Infilling or transforming existing front porches should be discouraged.
- Additional curb cuts.
- Multi-family apartment buildings and buildings out of character with the area.
- Garages and parking entered from streets should be discouraged.

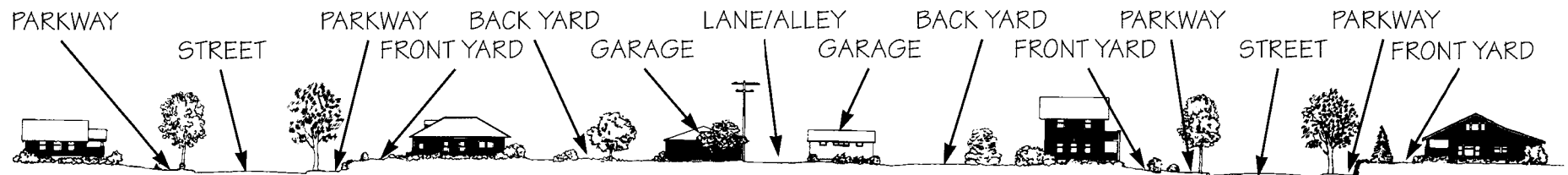

TYPICAL SECTION THROUGH TOWN CORE RESIDENTIAL AREA

Along San Dimas Avenue

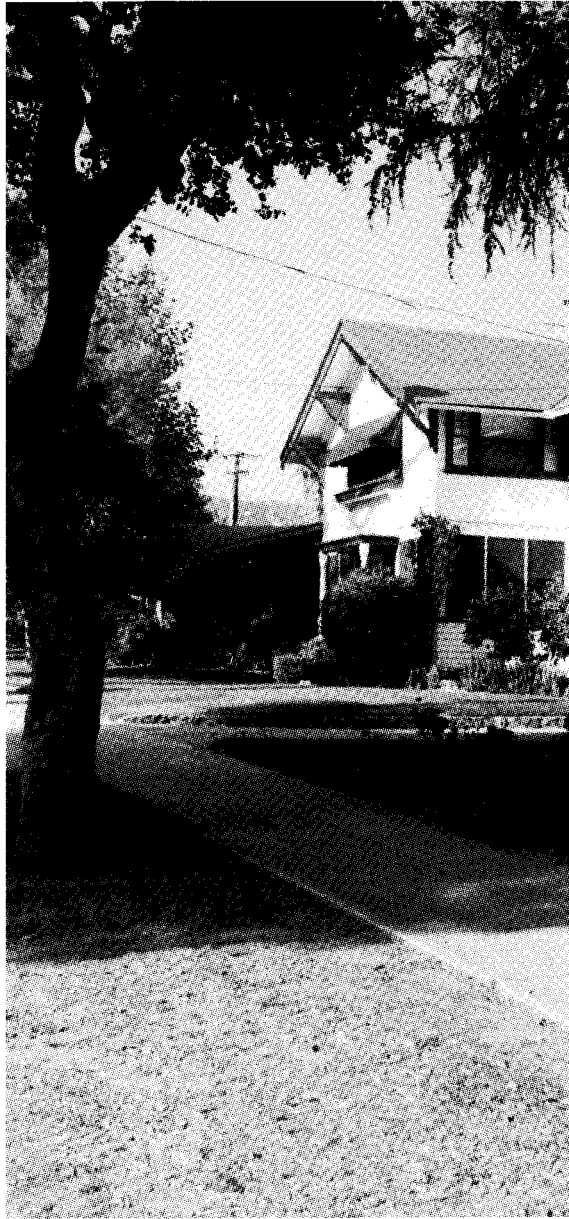

SAN DIMAS AVENUE LOOKING NORTH

Along San Dimas Avenue between Bonita Avenue and Gladstone Street are many of the finest, older buildings in the Town Core. Along either side of the roadway are narrow parkways planted with mature oak trees. This combination of mature oak and large, older houses is, along with the Bonita Avenue Frontier Village, responsible for the townscape character that gives San Dimas its identity. Appropriate measures should be taken to protect both the historic houses and the mature native trees along San Dimas Avenue.

San Dimas Avenue is wider than the other roads within the Town Core area. It is the major connection north to Foothill Boulevard and south to Via Verde. Many people who use the downtown area arrive by travelling along San Dimas Avenue.

The older houses along San Dimas Avenue are often larger and grander than most houses in the remainder of the Town Core. Setback distances are for the most part consistent, but the scale and quality of buildings change from smaller and less grand to larger and more grand from Bonita Avenue toward Gladstone Street.

In recent years, commercial and office professional development has augmented, and in some cases, replaced

residential development along San Dimas Avenue between Bonita Avenue and Fourth Street. These newer, office professional, and commercial projects are in many cases insensitive to the pattern and quality of development established by the historic building fabric. Though commercial development along this section of San Dimas Avenue is regrettable, certain less intensive professional and commercial uses are more desirable in this traditionally residential district. Only uses that do not generate a high parking demand should be considered as appropriate.

Many of the larger, older houses along San Dimas Avenue could be successfully converted to uses such as professional offices without affecting their visual appearance. This change of use is undoubtedly the preferred option if the alternative is demolition and redevelopment. Should office professional and commercial development continue along San Dimas Avenue, this is the approach that is recommended. In any case, office professional and commercial development above Fourth Street should be discouraged.

Any additional parking that may be required should be incorporated so that curb cuts are minimized and parking areas are not visible from the street.

KEY ISSUES

- Maintenance of existing character.
- Protect existing buildings.
- Protect existing trees.
- Facilitate use of some residential buildings as commercial premises.
- Enhance streetscape with public improvement projects.

GENERAL RECOMMENDATIONS

- Architectural review of new construction should require the applicant to show the project in neighboring context.
- The development of inner block parking should be encouraged to support new, office professional uses in existing historic residential buildings.
- Large trees should be protected.
- Any further road widening should be discouraged.

RECOMMENDED PUBLIC IMPROVEMENTS

- Parkways should be retained or widened between the sidewalk and street. Parkways should be landscaped to include new elements, in addition to existing trees.
- A street lighting program should be

introduced that is sensitive to historic context.

- Introduce boundary/gateway markers at San Dimas Avenue and Gladstone Street, if within a historic district.
- Introduce paving stone or brick crosswalks at significant crossing points.

RECOMMENDED PRIVATE IMPROVEMENTS

- Limit building height to 30 feet except for special features.
- Existing setbacks should be maintained.
- Landscaped front yards should be maintained if buildings are converted for office professional uses.
- Existing residential buildings should be preserved and used as residences, or carefully rehabilitated and adapted for office professional uses below Fourth Street only.
- Existing parking that is visible from the street should be screened with landscaping or new construction.
- Signs for office professional and commercial properties along San Dimas Avenue should be designed to be compatible with the residential character of the street. Small unilluminated signs designed to be hung or placed on a building facade are acceptable.

DISCOURAGED PRIVATE IMPROVEMENTS

- Conversion of landscaped front yards into paved areas.
- Setbacks should not be less than those existing on either side of the project site.
- Existing residential buildings should not be demolished.
- Mature landscape should not be destroyed.
- Additional curb cuts should be discouraged.
- Commercial development or the conversion of residential properties for office professional and commercial uses should be discouraged along San Dimas Avenue above Fourth Street.
- Freestanding, monument or illuminated signs along San Dimas Avenue should be discouraged except in the case of churches and community buildings.

BUNGALOWS

**DIRECT FROM
BUNGALOW LAND**
Perfect Gems of Home Com-
fort and Attractiveness

My designs have been selected from the very best types of bungalows in Southern California, which have become so popular throughout America. They are practical in any part of the country. Special specifications are prepared by an expert familiar with all the details of eastern and northern localities.

Now is the time to build, as lumber and labor are 50 per cent cheaper than it was six months ago.

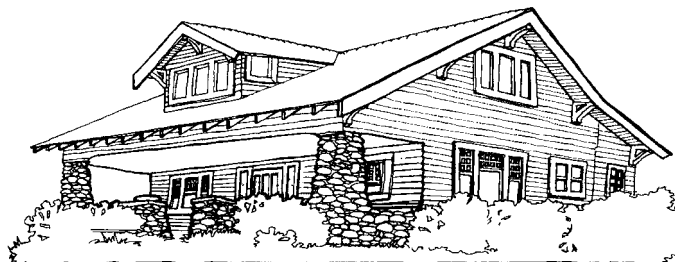

**If You are Interested
in Home Building—**

Design No. 18 Built of Stained Rustic
Siding and Shingles Cost \$2,200

Take Advantage of My Special Offer

I will send my book containing exterior and interior views of typical one and a half and two-story California residences—also 24 California Bungalows—prepaid in one package for one dollar—post office or express money order. These houses range in price from \$1,500 to \$10,000, and are the very best examples of Southern California Architecture.

To all who order plans this dollar will be rebated.

My experience of over ten years in the East enables me to prepare specifications and make structural details suitable for building these houses in cold as well as in warm climates

My terms, for making plans, etc., are stamped on the back of each photograph.

These designs are entirely different from anything that has been published along these lines.

F. G. Brown Architect

624-5 Security Bldg. LOS ANGELES, CAL.

Town Core Houses

This section introduces four groups of historic styles of prewar residential architecture that frequently occur throughout the Town Core area. Each of the four groups is illustrated with measured elevations. A short history of each style is also presented. Both the background history and illustrations are shown here to assist the home owner in identifying and understanding the important, special characteristics of the buildings discussed. This guide should be a reference for any rehabilitation or new construction within the Town Core area.

Many older homes have gone through minor or significant alterations and adaptations over the years, and some features explained may have been removed. When undertaking further work, the home owner should consult the information within the guidelines and formulate a design strategy that does not sacrifice the significant architectural qualities of the building. Furthermore, it may be possible to reinstate or restore significant architectural details.

It should be pointed out that the plan of a building is more than just a layout of rooms; the plan is a two-dimensional representation of the way spaces interrelate and ultimately the

way the spaces are used. Embodied within the plan is the spirit and character of the building and its architecture. Changes or additions to the plan of a building should be carried out in the spirit of the original design.

There are certain fine, historic homes in San Dimas that may not appear to be covered by the styles described in these guidelines. This is not an oversight nor should it suggest that these houses are not significant to the historic townscape of San Dimas. It would be impossible in these guidelines to cover all the variations of a particular style or architectural theme. Therefore we are limited to discussing those styles that are most representative and, consequently, most useful to the largest number of homeowners.

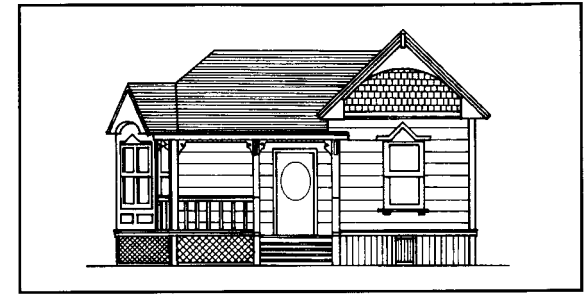

QUEEN ANNE



COLONIAL REVIVAL



CRAFTSMAN BUNGALOW

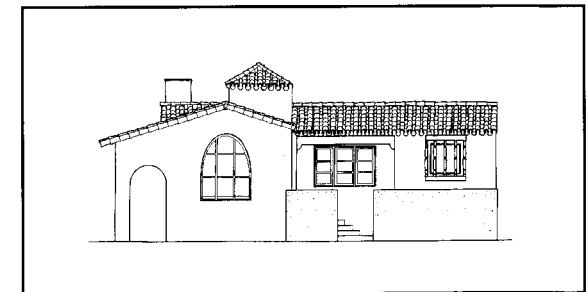

SPANISH COLONIAL REVIVAL

Queen Anne

Queen Anne architecture is based on the manor houses of the British architect Norman Shaw. The style was commonly referred to as 'picturesque,' in which the pieces of the building were collected together to form a picturesque composition.

The Queen Anne house is a mixture of different volumes and textures. The picturesque quality of the typical Queen Anne house is emphasized by the use of these different materials and by an asymmetrical composition. The merging of different roof shapes, such as round-corner towers with peaked caps intersecting pitched gables, emphasizes the asymmetry of the plan. Details are classical in nature. Columns, dentils, scrolls, and sunbursts are used.

The picturesque assembly results in an irregular floor plan and an irregular structural arrangement. Despite this irregular arrangement, spaces flow easily from one to another around a large central hall. The rooms themselves are full of interesting angles and corners, and are further elaborated by verandahs, towers, single and double-bay windows, and projecting gables. The San Dimas Mansion, located at 121 North San Dimas Avenue, is an outstanding example of the Queen Anne style.

The Queen Anne Cottage is also well represented in the Town Core of San



Dimas. The floor plan is a smaller-scale version of the Queen Anne House floor plan. Rooms are connected through archways, and the central space is more of a central vestibule than a hall. The appearance of the one or two-story cottage is overwhelmed by a large gable, which is usually decorated with shingles cut in different patterns. Typically the Queen Anne Cottage has a bay window that, together with a cut-away corner, forms an entrance porch under the gable.

Plan

- The plan is irregular.
- Rooms radiate around a central hall or vestibule.
- Spaces flow from one to another, although the rooms remain well-defined as individual entities.
- Rooms are irregular in shape and size.
- Rooms are connected together through archways.

Roof

- The main roof is steeply pitched.
- A gable roof is presented to the street with overhanging eaves.
- At the corner, spindled brackets support the overhang and a pendant.
- An attic dormer window functions as a vent or light source and adds to the irregular image of the style.
- Typical roofing materials are wood or composition shingles.

Porch

- Typically, the front porch is wide with a wraparound verandah.
- Alternatively, a cutaway corner together with a front bay window form an entrance porch under an oversized gable.
- Decorative columns support the gable or porch roof.
- Porch details include cutout stickwork or carved balustrades.
- Balconies are sometimes recessed into the second floor.

Walls

- Exterior walls are covered with horizontal clapboards or drop siding, which often extend over the foundation to the ground.
- The gables are ornate with decorative shingles cut in diagonal and half-round patterns.
- The gable might also be framed with intricate bargeboard, stamped with a sunburst, and topped with a finial.
- A less elaborate gable may only have scalloped shingles and a perimeter of dentils.

Windows

- Windows are always divided into smaller panes.
- With double-hung windows the upper part is typically surrounded by small squares of flashed glass.
- Glass is often patterned or colored for use in windows and doors. Sometimes two pieces of glass would be installed to create a third hue.
- Windows in the main front rooms are likely to be extra large and are often paired or have sidelights.
- Leaded, stained-glass windows are common, especially for the stair-landing window.
- Windows have broad wooden surrounds.

Columns and Railings

- The Queen Anne-style column represents no single motif, but it is a mixture of styles; the column has a beaded base, truncated shaft, and ad hoc capital.
- Detailing of the columns is not strictly classical but is derived from classical designs.
- Wooden railings around the porch usually have cut out stickwork or carved 'table leg' balusters.

Colors

- Queen Anne houses were originally painted several different dark colors to highlight all the intricate detailing.

Foundations

- Foundations are always raised, and the building often has a partial basement. The raising of the Queen Anne Cottage on a high foundation gives the diminutive building a grander presence.
- Foundations are usually covered with horizontal or vertical siding to form a skirt around the base of the building. The building appears larger than its floor plan would indicate.

Colonial Revival

The picturesque architectural styles of the Victorian era were followed by the Colonial Revival in the last years of the 19th century. A return to a more symmetrical style was a result of the nostalgia generated by the 1876 Philadelphia Centennial and the 1893 Columbian Exposition in Chicago, which favored the neoclassical style. Houses took on straighter lines and flattened ornamentation. San Dimas has a number of such houses in the Town Core area.

Typically, the houses of the Colonial Revival are one-story houses on raised foundations. A dormer window protrudes from the center of a hipped roof, which often has bell-cast ends. The design is very compact, with an emphasis on strict geometrical forms and classically inspired decorations.

The floor plan is rectangular with the short side oriented to the street. The living room is the room closest to the street and is entered from the porch.



Plan

- The plan is rectangular.
- The porch is recessed at the front under the hipped roof.
- Sometimes a sleeping porch is built at the rear.
- The living-room on the street often has a slanted or square bay window.
- There are often modest bay projections (slanted or square) at the sides of the house.
- Unlike the later Craftsman house the Colonial Revival house has no built in furniture elements.
- The planning is more formal than either the planning of the Craftsman house or the Queen Anne house.

Roof

- The roof is hipped, of moderate steepness, and often has a bell-cast shape.
- The roof has a centrally placed dormer window to light and ventilate the attic. The dormer breaks up the mass of the large roof.
- The attic was not designed and is rarely converted to living space.
- The large, hipped roof reaches out over the recessed porch and rests on classical columns.

Porch

- The porch is generally recessed under the hipped roof.
- In the recessed configuration, the porch appears as a quadrant of the plan, a kind of outdoor room.
- As the plan has no entry hall, you enter the house directly from the recessed porch. Thus the porch acts as a foyer.
- An attached porch was also designed for the Colonial Revival house, but this version is less common in San Dimas.
- The attached porch has a small, hipped roof that attached to the main roof.
- In both cases, the porch has neoclassically inspired columns supporting the roof.
- A terraced stoop often flanks the front porch steps.

Colors

- Originally, the Colonial Revival house was painted white or cream or subdued tones of gray.
- Trim was usually white with black window sash.

Windows

- Windows are small-paned and made of wood.
- Windows are usually double hung.
- Due to the long deep lots, light is admitted mainly through the front and rear, and the largest windows appear at these locations.
- Side windows are often square with angled bay windows, which also admit light into the house from the front and rear directions.
- Typically, the living room has a square or angled bay window facing the street.
- Wide and flat wooden trim frame the windows.
- Windows are sometimes shuttered.

Walls

- The walls are typically covered with narrow clapboards.
- The detailing of the walls is classically inspired with cornice and entablatures running along the eave.

Columns and Railings

- Columns are often abbreviated and rest on a short wall that encloses the porch.
- Character of the columns varies from house to house. They can be square and chunky with Doric features or turned and slender with simplified Ionic capitals.
- A railing design sensitive to the colonial motif is integrated into the column rhythm.
- Stairs to the raised porch did not originally have railings. If the foundation is high, railings might have been added later for safety.

Foundations

- The foundation of the Colonial Revival house is always raised. The height of the foundation gives the building a grander scale and sets it above the street.
- The foundation is usually covered with drop siding.

Craftsman

INTRODUCTION

The Craftsman style was derived from the traditions of the Arts and Crafts movement (1876-1916), which originated in England through the efforts of William Morris. In America, the foremost proponent of this movement was writer and designer Gustav Stickley.

The Craftsman period was a reaction to the machine age and mass-produced detail of the Victorian era. Part of the philosophy of Morris and Stickley was “to teach that beauty does not imply elaboration or ornament.” The Craftsman style, centered in Southern California, reflected simplicity of form and “natural” materials, with an emphasis on wood, native stone, and earth-toned colors. As the Craftsman movement encouraged interaction between indoors and nature, verandahs and porches act as transitory spaces.

The Craftsman houses found in San Dimas are typically Craftsman bungalows. The term “bungalow” was derived from the Hindustani word meaning “belonging to Bengal.” The British Anglicized the term to “bungalow” and used it to describe resthouses along the main road. The houses were low in profile with

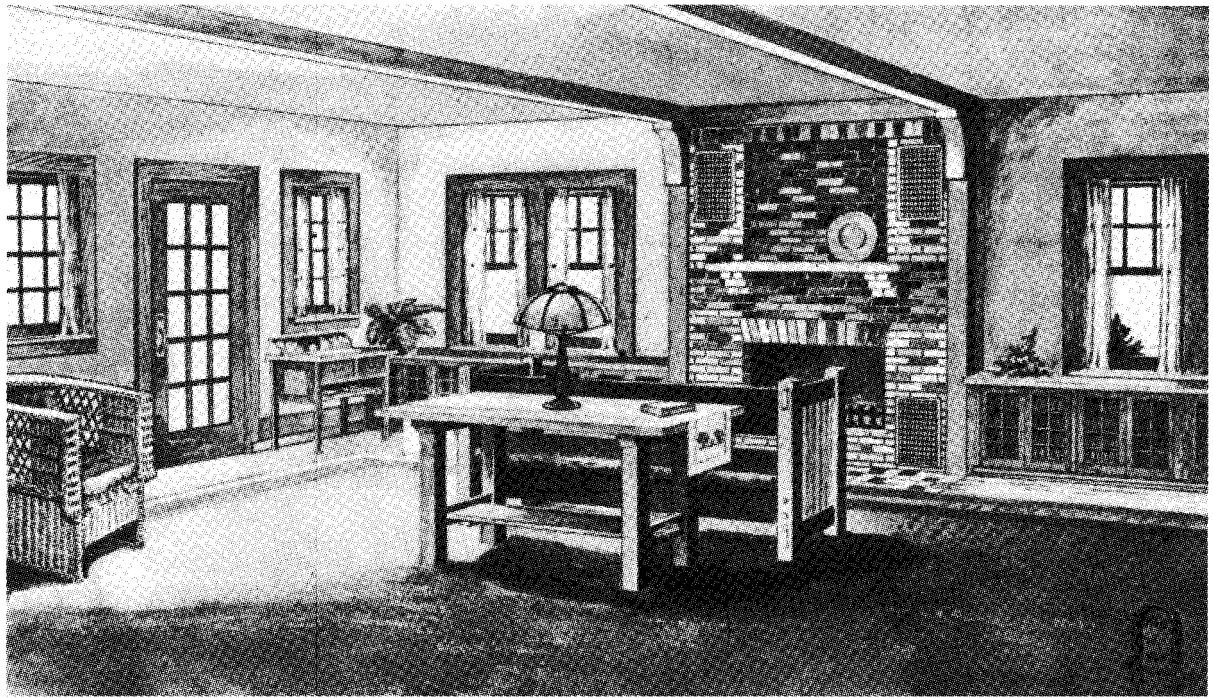

TYPICAL INTERIOR OF A CRAFTSMAN HOUSE

verandahs. A broad gable roof creates the aesthetic character of the bungalow by making sharp contrasts in line and shade. Overall proportions are low to blend with the site.

The floor plan of the bungalow is an expression of the Craftsman ethic. The front door opens directly into the living room, which itself spills directly into the dining room. The space is free flowing without corridors. Key design factors were comfort and convenience.

The interior of the Craftsman Bungalow uses wood for nearly all

elements. The walls, floors, beams, built-in cabinets, and benches provide a wealth of wood grain texture and pattern. Wood is usually stained and not painted.

Bungalow houses became extremely popular in California from 1900 to 1923. People liked the informal plans, and builders had a variety of bungalow plan books from which to build something everyone could afford. The new attitude toward comfort and convenience marked the introduction of the 20th century California way of life.

Versions

A majority of the old houses in the San Dimas Town Core area are different versions of the Craftsman Bungalows. They are one, one and a half, and two-story houses that can be recognized by the use of natural materials, their emphasis on structural forms, and their demand for fine craftsmanship. The word “bungalow” refers to the casual and informal way of life that the style promotes, rather than to the height of the building.

The exterior images of a one-story Craftsman Bungalow and 1 1/2-story Craftsman Bungalow differ chiefly in the orientation of their broadly pitched gable roofs. The latter version usually has its roof facing broadside to the street. With a dormer window, it maintains the visual image of having a gable over the porch. The dormer window brings light to the second-floor living quarters.

The two-story Craftsman Bungalow is a larger version of the above-mentioned houses. It typically has spacious second-floor balconies and sleeping porches to reinforce the Craftsman idea of the interaction between indoors and nature.

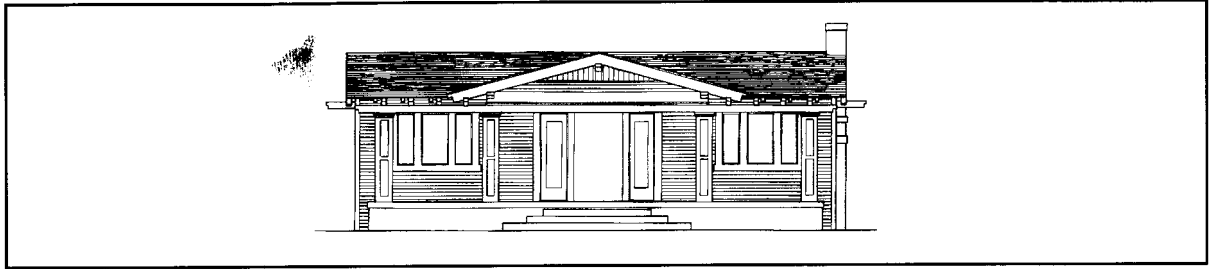

ONE STORY

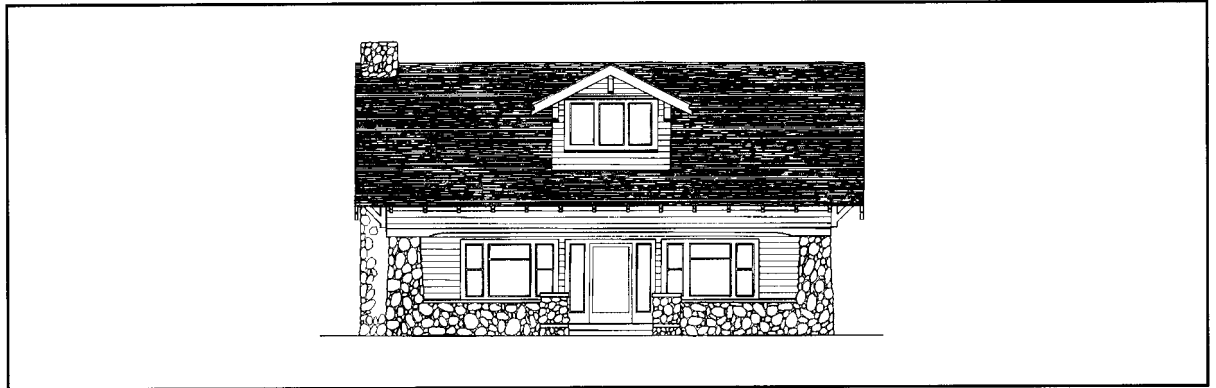

ONE-AND-A-HALF STORY



TWO STORY

One-story Craftsman Bungalow

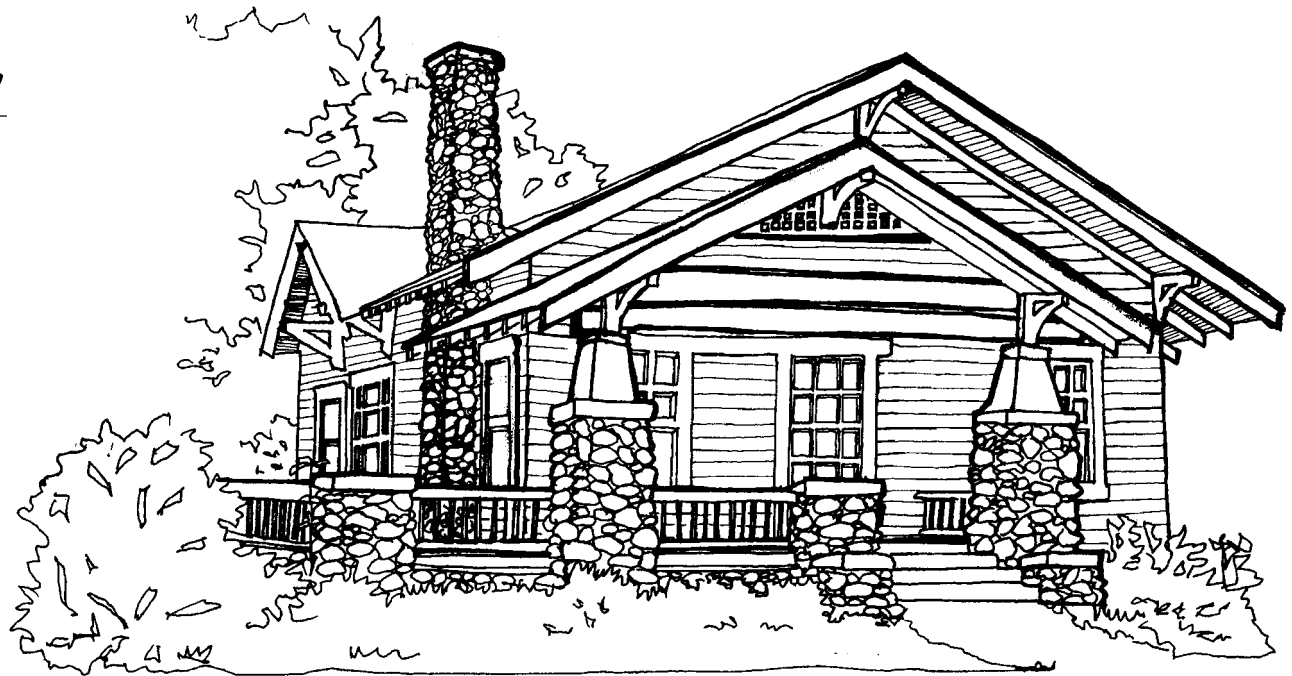

64

Roof

- A large, low-pitched gable roof with the gable end fronting the street is characteristic.
- A small gable caps the entry porch with a large gable behind.
- Open eaves overhang and are supported by projecting brackets, which are typically fine and craftsman-detailed.
- The roof space is usually not habitable, and no dormer windows appear on the roof.
- Roof materials are either wood or asphalt shingles.

Porch

- The porch is the most important feature of a one-story Craftsman bungalow.
- The porch is usually attached and appears as a raised pavilion to the street frontage.
- The porch acts as an element of street “furniture” as well as an entry “hall” to the house.
- From the porch, one enters the living room directly without intermediate foyer. In this configuration, the porch acts as an entry hall.
- The porch roof is supported by heavy columns or piers.

Plan

- The form of the plan is either rectangular or square.
- The scale suggests an intimate and informal atmosphere.
- Entry from the porch is directly into the living room.
- Spaces merge together informally without corridors—from living room to dining room to kitchen and bedrooms.
- The kitchen is usually large enough to allow some of the meals to be taken there.

One-and-a-half-story Craftsman Bungalow



65

Roof

- A large, medium-pitched gable roof has its broadside to the street.
- The roof reads as a single umbrella.
- A dormer window with a gable or shed roof oriented to the street admits light to the second floor.
- The open eaves overhang with exposed beams and rafters.
- The roof overhang is supported by projecting knee brackets.
- Exposed elements, rafters, beams, and brackets are carefully detailed with fine craftsmanship.
- Roof materials are either wood or asphalt shingles.

Porch

- The entry porch is recessed under the main-roof structure.
- The roof over the porch is supported by large pillars in either stone or wood.
- The porch is typically raised above the sidewalk by two to four steps.

Plan

- An informal floor plan with no halls or corridors is typical.
- The living room is entered directly from the front porch.
- Bedrooms are upstairs, where lighting and ventilation is through side windows and the dormer window.

Two-story Craftsman Bungalow



66

Roof

- A two-story Craftsman bungalow has typically one or more medium-high, broadly pitched gable roofs; The effect is of a unified umbrella.
- Usually, the main gable fronts the street.
- A decorative lattice of wooden vents is placed in the top of gable peaks.
- The various facades are usually non-symmetrical.

Porch

- A recessed or attached entry porch typically holds the second-floor balcony under the front gable.
- The porch is sometimes enclosed to form a glass or screened entrance verandah.
- Porches and verandahs are transitory spaces between the outdoors and indoors.
- Screened sleeping porches are common in the larger houses.

Plan

- The interior is divided into three zones: parts used during the day, such as halls, living rooms, studios, porches, and balconies; bedrooms and bathrooms; and the kitchen and service portion.
- Porches, verandahs, balconies and screened, sleeping porches are very characteristic of the style.
- Interior living spaces merge together and the space flows from one room to another.
- The division between rooms is achieved with half walls with or without posts.
- The plan has no corridors.

Windows, Doors, & Vents

- The windows of the Craftsman bungalow should be considered more as frames for attractive vistas than merely as openings for light.
- The front window is typically a casement window and usually has special detailing with square-shaped panes, leaded diamond shapes and so forth.
- Front windows are divided into three parts, but, beyond that, no two windows are exactly alike.
- Mullions can have an irregular geometric pattern.
- The central window is always the largest of the three panels.
- Often the front door arrangement is handled in the same way as the window, with two narrow panels of glass flanking either side of the entry called sidelights.
- Double-hung windows are often used at the sides and rear.
- Craftsman windows are outlined with wood casings and they are grouped in horizontal bands to emphasize the bungalow's broad image.
- The dormer window is designed in careful proportion to the rest of the house.
- Vents usually have wooden screens with robust wood detailing.
- Windows are always made of wood.

Columns

- The two large pillars that support the front porch gable are typically broad at the base, slightly tapered at the top, and somewhat foreshortened.
- Columns are made out of wood or stone.
- Columns often rest on pedestals that rise up out of the foundation.
- Pedestals with columns serve as end posts for the porch railings.
- Massive columns give the porch a monumental image and scale.

Colors

- The color scheme follows as far as possible the materials' natural hue and texture.
- The natural materials, stone and wood, are usually untreated except for an occasional stain to darken the wood.
- The moderation of color is compensated for by the aesthetic character of the overhanging roof that makes a sharp contrast in line and shade.

Walls

- Exterior walls are covered with shingles or horizontal siding; drop siding, bevel siding, and clapboard are all commonly used.
- Walls are designed to relate to the natural surroundings and are always made of wood.
- It is also common for the first-floor wall to be covered with clapboard and the upper story to be shingled.
- Interior walls are commonly half covered with a wooden wainscot.

Foundation

- A Craftsman bungalow sits on a raised foundation that usually is made of local stone, clinker bricks, or textured blocks.
- The foundation raises the bungalow above the level of the sidewalk by two to four feet.
- The raised foundation gives the bungalow a grander scale than would be achieved if the building rested directly on the ground.

Craftsman Interiors

Interiors in Craftsman homes are as richly detailed as the exterior. Natural material, wood, stone, brick, and glass, are used to create warm, friendly interiors. Living room spaces often have a wainscot (half paneled wall) of douglas fir usually stained. The fire-place, usually faced in stone or brick, ties into the wainscot paneling to form the major feature in the living room. Sometimes the fireplace is set off the living room in a smaller space

with built-in seating called an inglenook, as in the illustration below.

Built-in furnishings are part of the craftsman aesthetic, which help make the interior welcoming even when it is sparsely furnished. The dining room will often have a built-in sideboard, with glass fronted cabinets for display.

The open plan of the Craftsman home is usually divided with low, wooden room dividers with columns and wood screens. Often wood ceiling

beams are exposed, which add character and scale to the major rooms. Raised floors in Craftsman homes are always made of wood. Hardwood is used in the downstairs areas, and softwood is used upstairs.

When considering remodeling, craftsman interiors are nearly as important as the exterior. Preservation of interior features and treatments should be a priority in any remodeling or restoration project.

68

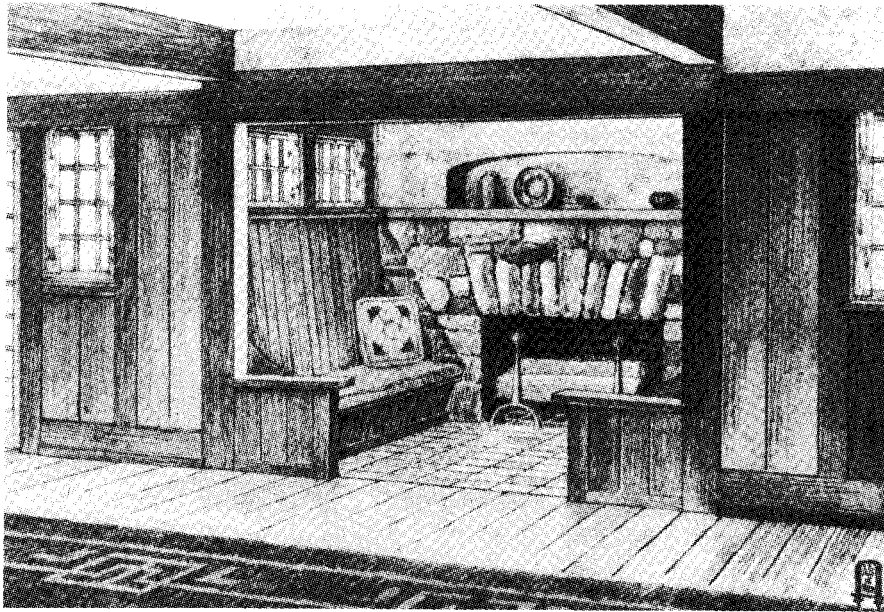

VIEW OF THE FIREPLACE NOOK, WITH ROUGH TILE HEARTH AND WAINSCOTTED WALLS

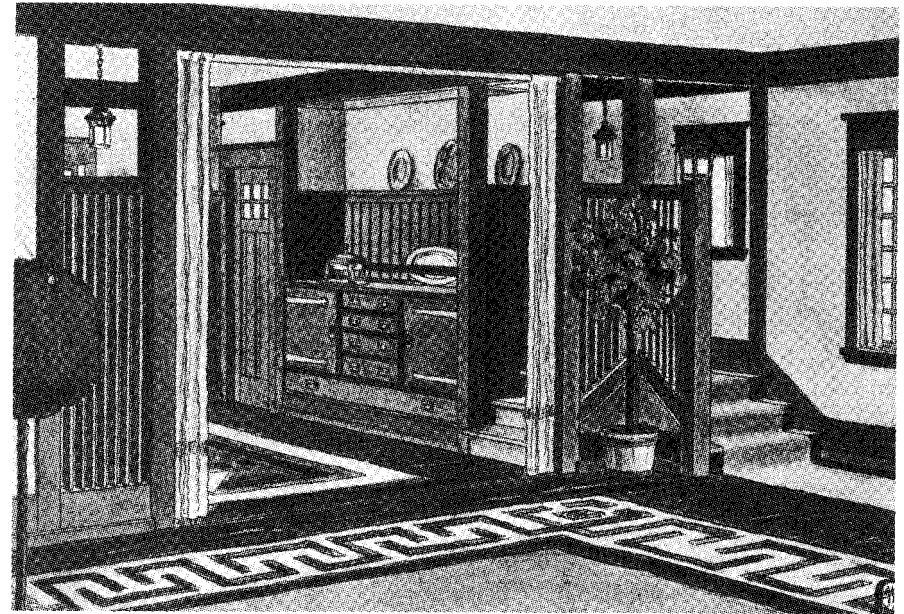

LIVING ROOM WITH DECORATIVE WOODWORK AND STRUCTURAL FEATURES

Spanish Colonial Revival



70

The Spanish Colonial Revival (1915-1935) was among the most popular styles, receiving its impetus from the Panama Exposition at San Diego in 1915 to celebrate the opening of the Panama Canal. This style includes elements from Italy, Spain, and North Africa, and, therefore, it is often referred to as a Mediterranean style.

A single-story house of the Spanish Colonial Revival can easily be identified by its terra cotta tile roof and white stucco. The roof can be pitched or flat, and often only the porch or parapet is roofed with tile. The combination of white stucco and tile sets the Mediterranean style for the entire house. It is also characteristic of

the style to have arches, typically in porches, and in main doorways and windows. The garden is usually axial and directly related to the symmetry of the house, its plan, and its interior spaces.

The coastal climate of Southern California is very similar to the climate of the Mediterranean. The similarities in the environment mean that houses built in this style look very at home in California and fit right in with the landscape.

Plan

- The Spanish Colonial floor plan typically has more projecting elements than other house styles.
- There are fewer built-in elements than found in the Craftsman style.

Roof

- The roof is usually low-pitched with terra cotta roof tiles.
- Alternatively, the roof is flat and has the characteristic tiling on the porch roof or on parapets.

Porch

- The porch of the Spanish Colonial Revival house is an entry porch with arched openings, rather than the porch as sitting room that is found in the Craftsman bungalow.
- The porch links the house to the outdoors, through French doors, terraces, and pergolas.
- Pergolas are made of large timbers that are carefully, though roughly, detailed.
- The porch can either sit on a raised foundation or directly on the ground.

Walls

- The exterior walls of the Spanish Colonial Revival house are invariably sheathed in stark white stucco as a dramatic counterpoint to the undulating roof tiles.
- The interior walls are covered with a rough, almost lumpy plaster, that is either white or an integral earth tone to simulate adobe.
- Dark wood beams are exposed across the ceiling.
- Glazed and unglazed tiles are used for walls and floors.

Windows

- Windows are usually six-part, wood-frame casement windows or double-hung windows.
- There are usually a limited number of openings.
- Typically, openings are deeply cut into the wall surfaces without exterior window frames or surrounds.
- The front window and door are usually arched. Arches come in many variations: pointed, rounded, flattened, and so forth.
- The front window is often detailed with twisted columns or pilasters, which support a small roof over the window.

Columns & Railings

- Distinctive twisted columns may support the front porch roof in post and lintel fashion.
- Twisted columns are also commonly used to frame the living-room picture window.
- Wood or wrought iron is used for second-story balcony railings on larger homes or as window grills on cottages.
- Turned wooden balusters are often used as porch balcony railings.

Colors

- Walls are painted white.
- Window frames are painted burnt sienna or occasionally turquoise blue.
- Roofs are the natural color of terra cotta.
- Iron railings are usually painted black.

Foundation

- Raised foundations are used at the perimeter of the building.
- Raised foundations are stuccoed flush with the wall above, the stucco finish continues to the ground level.

Town Church and Community Buildings



72

Within the Town Core are a small number of significant community and church buildings. The demolition or significant alteration of these buildings would be a major loss to the historic fabric of the Town Core. These buildings share similar stylistic qualities and building technologies with other buildings in the town, which are contemporary in their construction. Though stylistically similar, these buildings are larger, grander, and often more elaborate than the residential buildings of the period.

The location of these buildings within the Town Core is significant. As special buildings, they help us orient ourselves in the town. Most of the churches and community buildings are located on corner sites or along San Dimas Avenue.

In recent years, as parking demands have increased, adjacent residential sites have been acquired and transformed into parking lots. Although these parking areas are no doubt useful, they detract from the residential scale and quality of the

neighborhood. Future parking needs should be fulfilled with careful consideration for the maintenance of the Town Core's historic fabric, density, and scale.

For the most part, the buildings have changed little since their beginnings. Alterations and repairs have been carried out sensitively with regard to the building's original architecture. The relevant style, as discussed in this section of the Town Core Guidelines, should be consulted for further alteration and rehabilitation projects.

Recommend

- Future improvements, alterations, or rehabilitation should be carried out under the supervision of an architect.
- Parking lots should be screened from the surrounding neighborhoods by carefully planned and well-maintained landscape.
- In reroofing these buildings, every

- effort should be made to match or closely approximate the materials and methods employed when the building was originally constructed.
- Repairs, as in the case of the Mansion chimneys, should be carried out using materials and methods similar to that employed when the building was

- constructed and not replaced with features that are visually different from the original (i.e. stucco).
- Repainting of these buildings should be considered by the Architectural Review Board.

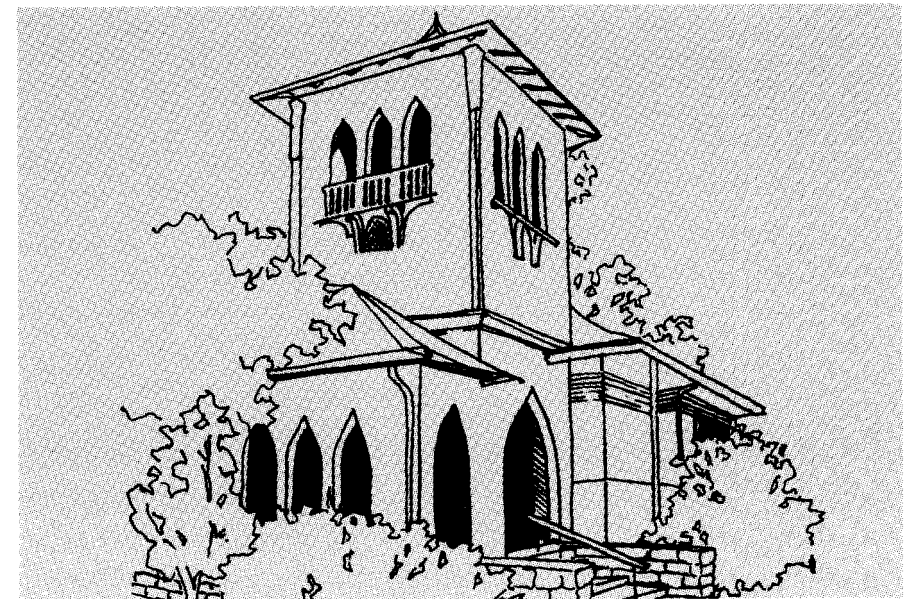
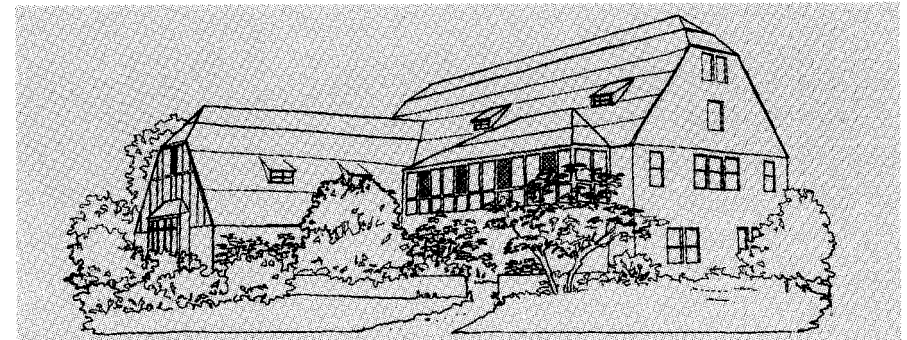
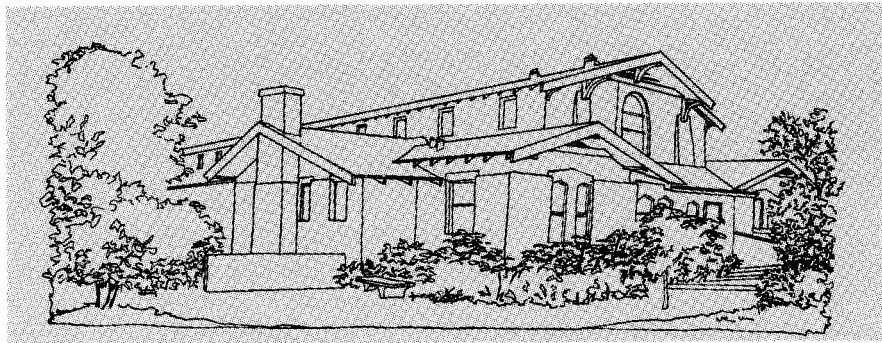

General Guidelines

Town Core

NEW BUILDING WORKS

It is not necessary that new buildings in the Town Core look as if they were historic buildings. In fact, this approach leads to pastiche, confusion, and undermines the value of our true historic resource. However, new buildings should respect the historic context in which they are placed. New buildings should use their sites in a manner consistent with the site plans of the large majority of buildings in the Town Core. New buildings should be designed to an appropriate scale and detail with the majority of buildings in the Town Core.

The topics in this section review those architectural characteristics which are important to consider when designing new residential buildings in the Town Core. They are similar to those discussed under the Historic Buildings Guidelines. Each topic is treated in a general way, and general guidance is given. Each site and each project is unique, however, and certain topics may not apply.

When considering new residential building designs in the Town Core:

- Review the Town Core Residential Guidelines for an overview of the area



and recommended improvements.

- Review the historic building styles, which appear earlier in this section for information regarding the historic context into which your new building will be introduced.
- Study carefully and document those buildings and sites that are immediately adjacent to your project

site. This immediate context will be important when your building design proposals are reviewed by the planning department and the Development Plan Review Board.

- Finally, consult the topics on these pages for guidance regarding specific design and planning issues.

Site Planning

- All front and side-yard setback criteria should be adhered to.
- Front yards should be landscaped.
- No vehicular access, driveways, or curb cuts should be planned from the street frontage if an alley exists at the rear of the property.
- All vehicular access shall be from the back lanes.
- Frontage to the rear alleys should form a continuous edge of fences, gates, walls, or garage doors.
- The ground floor, finished-floor level should be 2 to 3 feet above the sidewalk level immediately in front of the property.

Building Plan

- One or 1 1/2-story buildings are appropriate for most areas of the Town Core. Certain sites can handle two-story buildings.
- As site dimensions are limited, simple plans afford the maximum efficiency with the largest area of useable space.
- The fronts of all buildings must relate to the street grid.
- Buildings must front the street and not the alleys.
- Garages should not be planned so that they can be entered from, or are highly visible from, the street.

Roof

- The primary roof should be treated as a large, single “umbrella.”
- Roof pitches should not be less than 3 in 12.
- Roofing materials should compliment building design.
- Overhanging eaves are preferred in most cases.
- Similar roofing materials and designs should be used on garages and outbuildings.

Porch

- In most cases, buildings in the Town Core should have a porch of substantial size fronting the street.
- The porch’s finished floor level should be close to the ground-floor finished floor level of the buildings.
- Porches can be either recessed or attached. A recessed entry on its own is not considered a porch.
- Porch steps or ramps should be designed to be in keeping with the building design.

Walls

- Wall finishes should be selected that enhance the architectural properties of the building, and the surrounding context and landscape.
- Natural materials should be considered for external wall surfaces.
- Similar wall finishes should be applied on all building facades: front, sides, and rear.
- Similar wall finishes should be applied to the garage or other outbuildings.

Columns and Railings

- Columns should be an integrated part of the design. Columns should carry structural loads and not just appear as decoration.
- Column details should be designed as a compatible part of the building’s architecture.
- Special columns on the porch are acceptable, but they should relate to the overall architectural design of the building.
- Railings and columns should be detailed in a similar manner.

Windows, Doors, and Vents

Windows, doors, and vents are elements that play a central role in determining the architectural quality and character of a building. The following general points are included for guidance, but the actual design or selection is a matter for detailed consideration. Many more window types are available today than was the case when the majority of buildings in the Town Core were constructed, and many different windows can meet the intentions discussed in the guidelines.

- Windows, doors, and vents should be designed or selected to closely relate to the building's architectural properties.
- Clear glass should be used.
- Window and door headers should align horizontally on the building facade.
- Window openings should be constructed to avoid a "flat" look. Windows set into the wall thickness result in shadow lines that give the building a richer, more modeled appearance.
- Windows and doors should have external trim.
- Consider window types that are, or appear to be, casement or double-hung.
- Door styles should relate to the architecture of the building; consider sidelights.
- Vents should be treated as aesthetic, architectural elements and not just included to satisfy building-code requirements.
- Consider internal sills and window surrounds; these add interest and detail to the interior spaces.

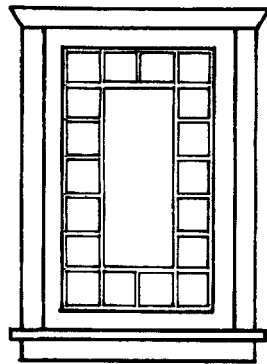

FIXED

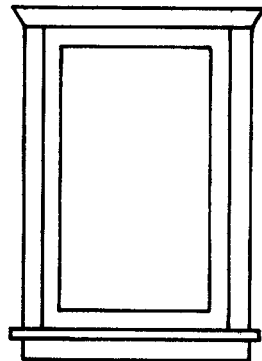

CASEMENT

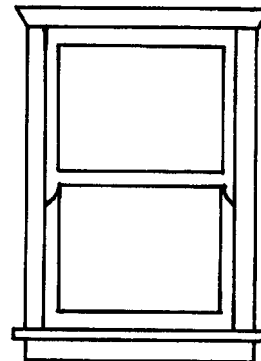

DOUBLE-HUNG

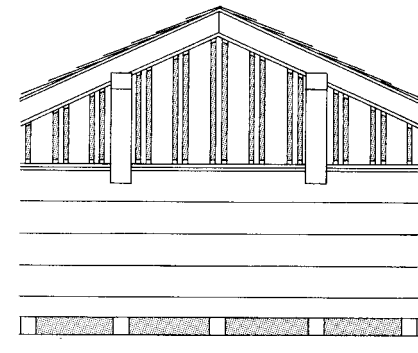

DORMER OR PORCH VENT

General Guidelines

Town Core

WORK TO EXISTING BUILDINGS

Most of the houses in the Town Core that were built prior to World War II contribute to the historic ambience of San Dimas. These buildings are often modest, yet they represent our inheritance and should be treated with respect. Those who have lived in these older buildings understand their qualities and charm.

San Dimas is unique in that it has a large number of historic buildings that, together, form complete neighborhoods. Many similar buildings throughout Southern California have been bulldozed in recent years for freeway projects and new tract development. These neighborhoods are within walking distance of the downtown shopping areas, a fact that should not be overlooked when considering the increased traffic congestion within the region. These neighborhoods will become increasingly more attractive as higher density and lower-quality development spreads throughout the Valley, and these buildings will become more valuable. As such, they are a resource.

Recommend

- Assess your house using these guidelines and the survey form in the appendix to determine how it differs from the examples sighted. Are the differences the results of the original construction or later alterations?
- Consult these guidelines and historic documents regarding your particular building, or documents that describe a similar building, before undertaking rehabilitation work.
- Insist that work carried out on your behalf be properly done, with a view to historic accuracy. Shortcuts often yield shortsighted and regrettable results.
- For original items, consider repair instead of replacement.
- When considering additions, modifications, or new decorating schemes, your tastes should not be the sole determining factor. Try to determine how your desires best fit with the architecture of your building.
- Consult an architect for advice regarding major rehabilitation or for the design of large additions.
- Consider accurate renovations of earlier, poorly done remodels.
- Consult the following pages of the guidelines for general advice on the dos and don'ts, which should be followed when undertaking additions to older homes in the Town Core.

Discourage

- Do not assume that you or your contractor are familiar with the historic techniques or the results desired in the rehabilitation process. Consult historic documents and consult the guidelines.
- Avoid inappropriate, over-scaled, or second-story additions. These designs will not likely receive planning consent.
- Do not infill porches.
- Do not consider new siding materials, such as aluminum or plastic.
- Repair original windows and doors where possible. Do not use aluminum or plastic replacement windows.
- Do not use tinted glass.
- When re-roofing, try to use materials that have a visual quality similar to the original roof material.
- Avoid block walls; consider wood fences, brick walls, or stone walls instead.
- Do not paint river-rock foundations.

Dos and Don'ts Town Core

Additions To Existing Buildings

Doors and Windows

The tops of door and window openings should align.

Do

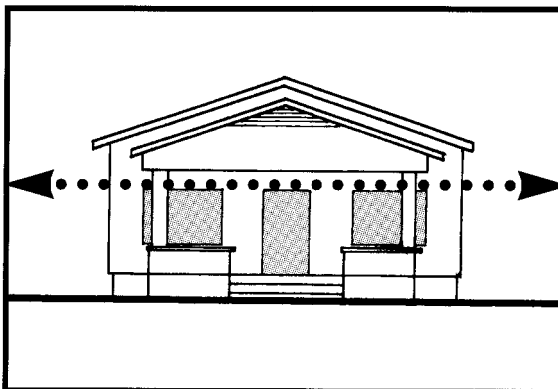

Don't

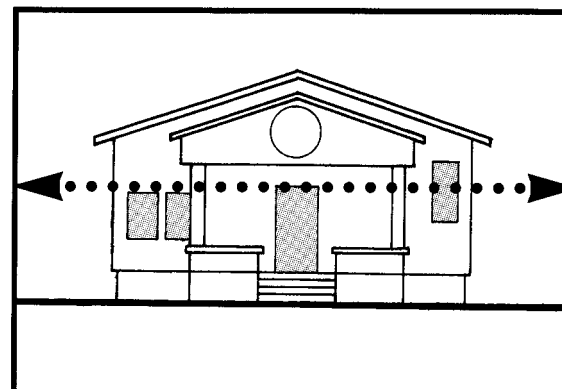

Porch Enclosures

The open porch is an essential element in most of the older homes in the Town Core. Open porches should not be enclosed.

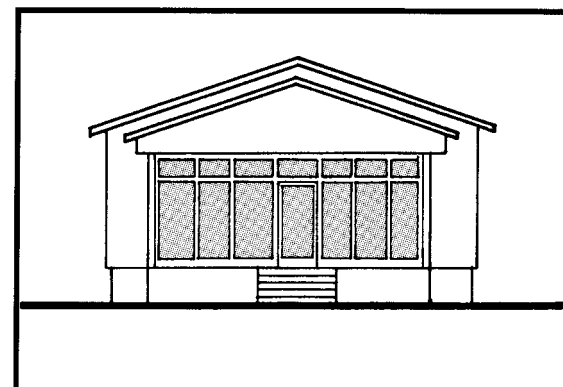
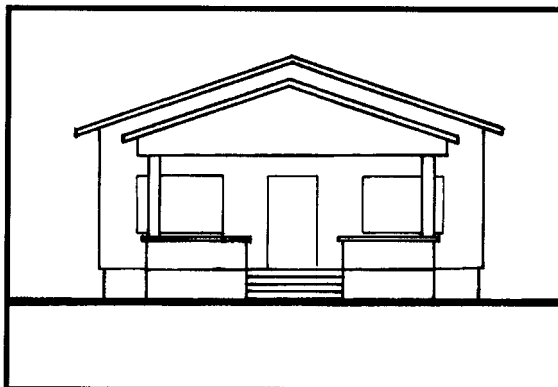

Materials

Materials used in additions should match the existing materials. Horizontal wood siding on the existing house means using horizontal wood siding on the addition. Do not change materials on the addition. Aluminum or masonite siding would not be acceptable materials if the existing house has wood siding.

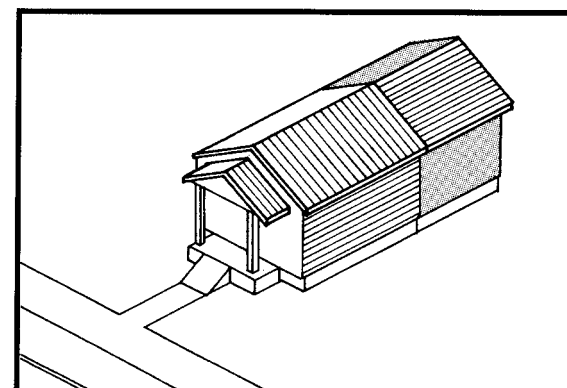
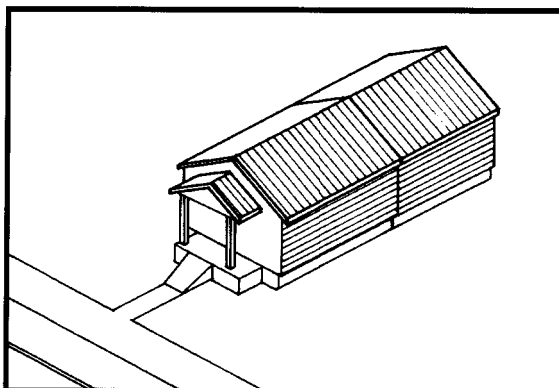

Symmetry

Many bungalows in the Town Core are designed symmetrically. This symmetrical composition should be retained in the design of new additions. Never build a non-symmetrical element into an existing building that is symmetrically designed.

Do

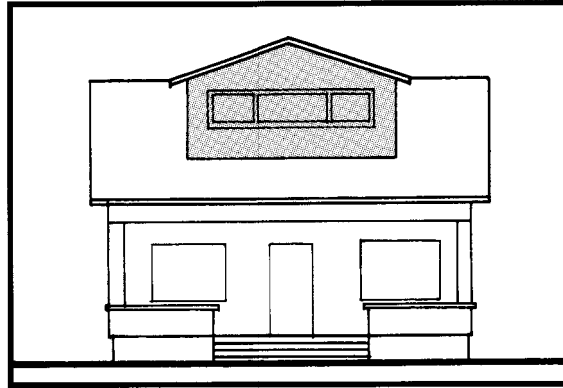

Don't

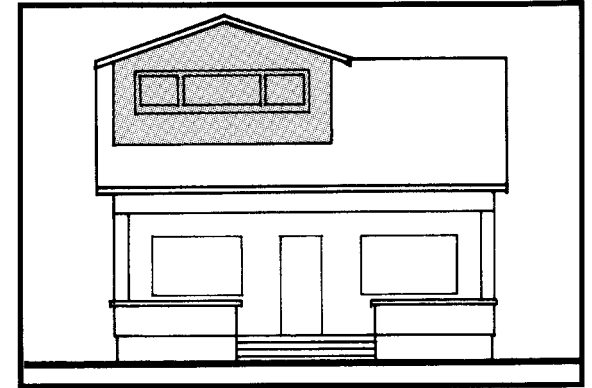

Dormers

New dormers should be designed with the same roof pitch and in the same style as the existing building.

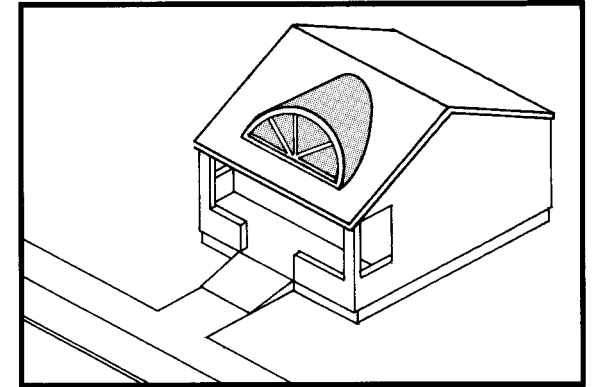
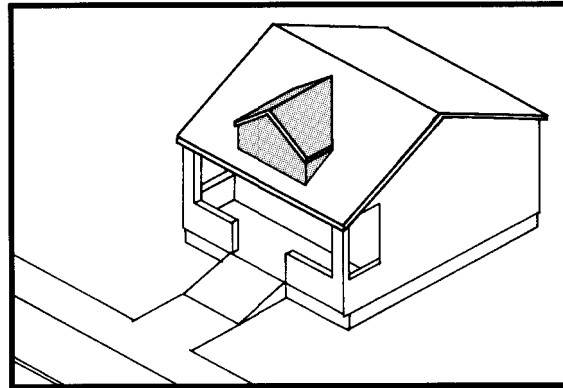

Roof Pitch

Roofs over second-story additions or lofts should have a roof pitch and roof type that is consistent with the existing building.

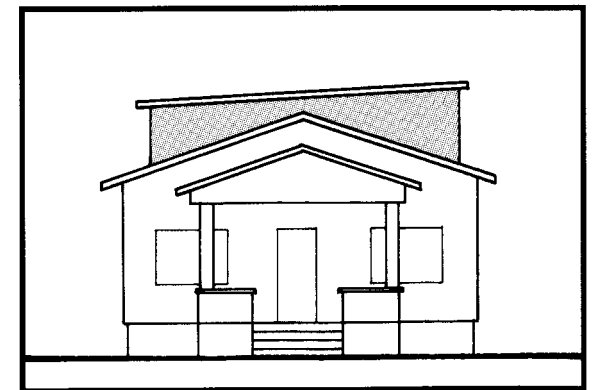
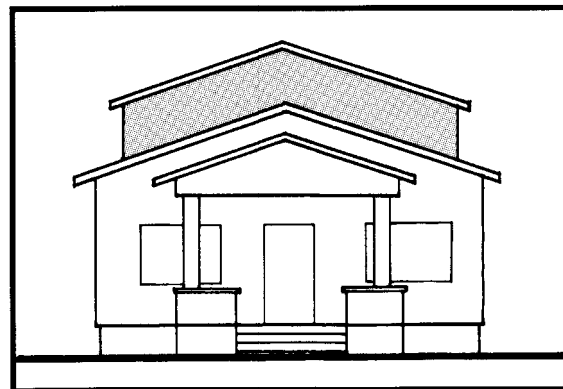

Do

Don't

Roof Forms

Roof forms over additions should match the style and pitch of the existing roof.

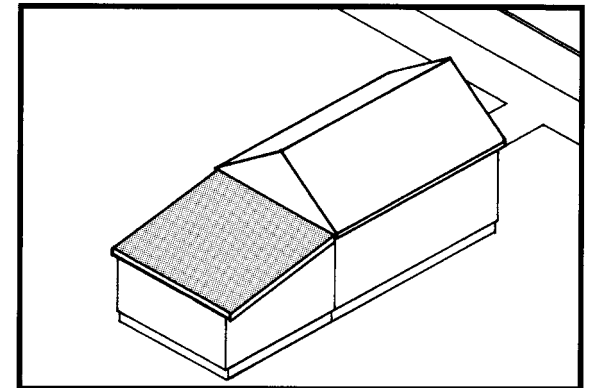
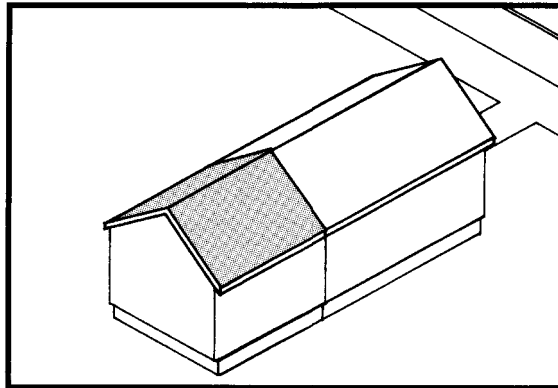

Roof Geometries

Roof geometries over additions to existing buildings should relate to the existing roof geometry. The final roof form should appear logical and facilitate good drainage.

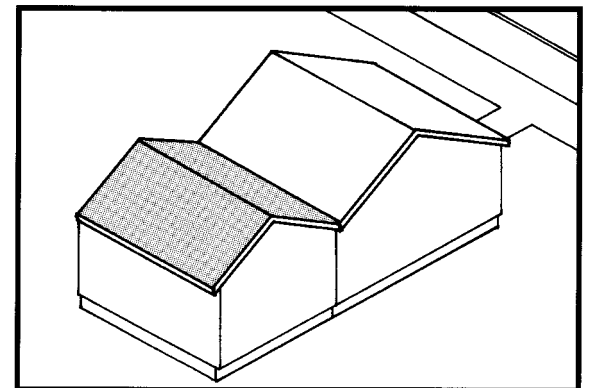
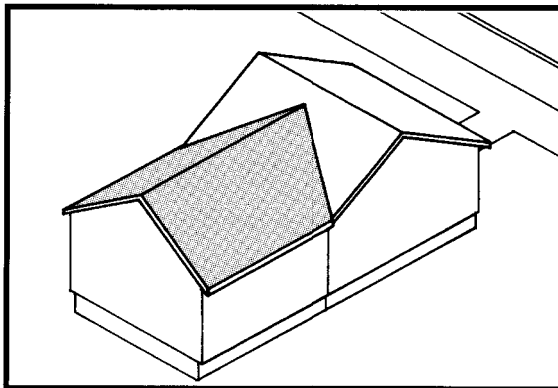

2nd Story Additions

Second-story additions are not generally advisable on most single-story buildings in the Town Core. If this addition is the only alternative, it should be planned so as to minimize its effect from the street frontage. Second-story additions should be planned as rear additions and never toward the street.

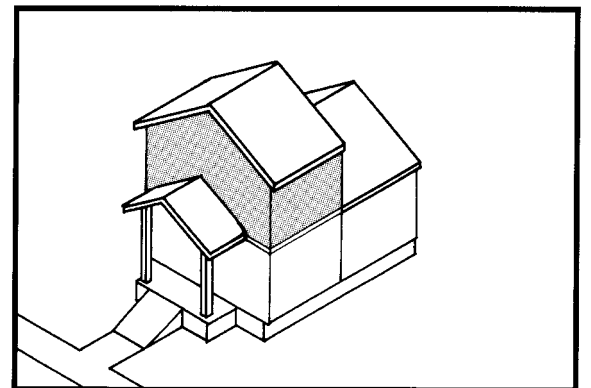
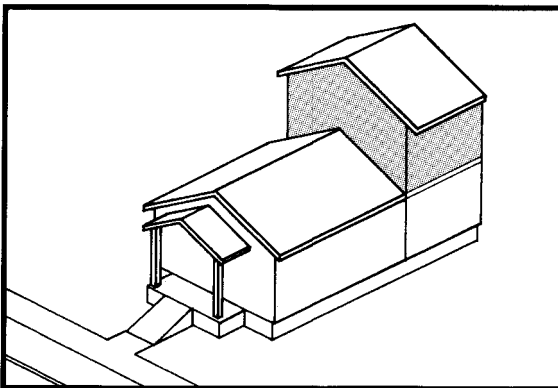

Site Plan Arrangements

Additions should be natural extensions of the house floor plan. Additions that wrap around a corner, are located at the front of the house or are irregularly shaped are not acceptable.

Do

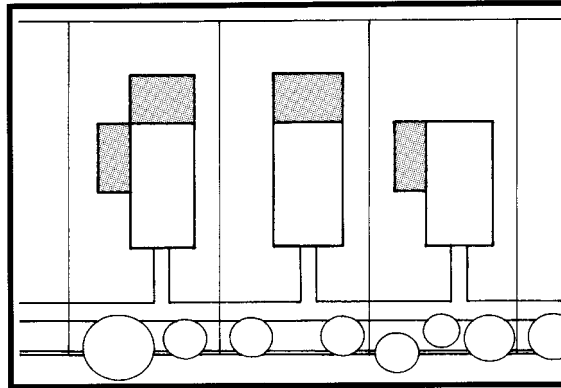

Don't

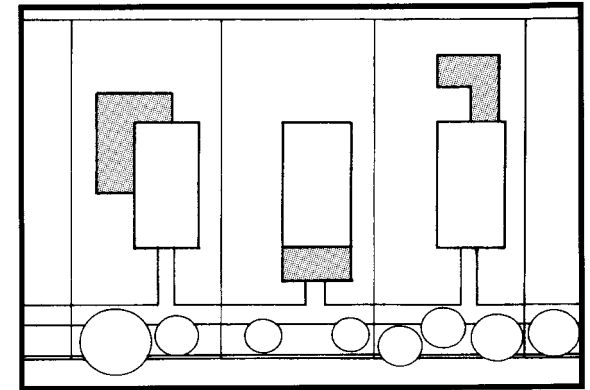

Curb Cuts

The streets in the Town Core were designed and built with a severe camber to facilitate drainage. Curb cuts interrupt smooth drainage flow and are difficult to construct to avoid bottoming out. Additional curb cuts in the Town Core are unacceptable. Driveways and garages should be entered from the alleys only.

